

Hyper 5 mm (T1 ¾) LED, Non Diffused Hyper-Bright LED

LS 5436, LO 5436, LY 5436



Vorläufige Daten / Preliminary Data

Besondere Merkmale

- **Gehäusotyp:** farbloses, klares 5 mm (T1 ¾) Gehäuse
- **Besonderheit des Bauteils:** Lötspieße ohne Aufsetzebene
- **Wellenlänge:** 633 nm (super-rot), 606 nm (orange), 587 nm (gelb)
- **Abstrahlwinkel:** 40°
- **Technologie:** InGaAlP
- **optischer Wirkungsgrad:** 11 lm/W (gelb, orange), 7 lm/W (super-rot)
- **Gruppierungsparameter:** Lichtstärke
- **Lötmethode:** Wellenlöten (TTW)
- **Verpackung:** Schüttgut, gegurtet lieferbar
- **ESD-Festigkeit:** ESD-sicher bis 2 kV nach EOS/ESD-5.1-1993

Anwendungen

- Informationsanzeigen im Innen- und Außenbereich (z.B. im Verkehrsbereich; Laufschriftanzeigen)
- optischer Indikator
- Hinterleuchtung (LCD, Schalter, Tasten, Displays, Werbebeleuchtung, Allgemeinbeleuchtung)
- Innenbeleuchtung im Automobilbereich (z.B. Instrumentenbeleuchtung, u.ä.)
- Ersatz von Kleinst-Glühlampen
- Markierungsbeleuchtung (z.B. Stufen, Fluchtwege, u.ä.)
- Signal- und Symbolleuchten

Features

- **package:** colorless, clear 5 mm (T1 ¾) package
- **feature of the device:** solder leads without stand-off
- **wavelength:** 633 nm (super-red), 606 nm (orange), 587 nm (yellow)
- **viewing angle:** 40°
- **technology:** InGaAlP
- **optical efficiency:** 11 lm/W (yellow, orange), 7 lm/W (super-red)
- **grouping parameter:** luminous intensity
- **soldering methods:** TTW soldering
- **packing:** bulk, available taped on reel
- **ESD-withstand voltage:** up to 2 kV acc. to EOS/ESD-5.1-1993

Applications

- indoor and outdoor displays (e.g. displays for traffic; light writing displays)
- optical indicators
- backlighting (LCD, switches, keys, displays, illuminated advertising, general lighting)
- interior automotive lighting. (e.g. dashboard backlighting, etc.)
- substitution of micro incandescent lamps
- marker lights (e.g. steps, exit ways, etc.)
- signal and symbol luminaire

Typ	Emissions- farbe	Gehäusefarbe	Lichtstärke	Bestellnummer
Type	Color of Emission	Color of Package	Luminous Intensity $I_F = 20 \text{ mA}$ $I_V \text{ (mcd)}$	Ordering Code
LS 5436-SV	super-red	colorless clear	180 ...1120	Q62703Q3626
LO 5436-UBW	orange	colorless clear	450 ...2800	Q62703Q3628
LY 5436-TAW	yellow	colorless clear	280 ...1800	Q62703Q3630

Anm.: Die Standardlieferform von Serientypen beinhaltet eine untere bzw. eine obere Familiengruppe oder mindestens zwei Einzelgruppen.

In einer Verpackungseinheit / Gurt ist immer nur eine Helligkeitsgruppe enthalten.

Die technologiebedingte Helligkeits-Streuung der heutigen LED-Herstellprozesse über einen längeren Fertigungszeitraum (Halbleitermaterial - Chipherstellung - Montageprozess) erlaubt keine Zusage einer einzelnen Helligkeitsgruppe. Daher müssen mindestens zwei Helligkeitsgruppen vorgesehen werden!

Note: The standard shipping format for serial types includes a lower or upper family group or at least two individual groups.

No packing unit / tape ever contains more than one luminous intensity group.

Luminosity variations caused by the technology used in current LED manufacturing processes over a protracted manufacturing period (semiconductor material - chip fabrication - assembly process) mean that it is not possible to assign LEDs to a single luminous intensity group. For this reason at least two luminous intensity groups must be provided!

Grenzwerte
Maximum Ratings

Bezeichnung Parameter	Symbol Symbol	Werte Values		Einheit Unit
		LS, LO	LY	
Betriebstemperatur Operating temperature range	T_{op}	- 55 ... + 100		°C
Lagertemperatur Storage temperature range	T_{stg}	- 55 ... + 100		°C
Sperrschichttemperatur Junction temperature	T_j	+ 100		°C
Durchlassstrom Forward current	I_F	30		mA
Stoßstrom Surge current $t \leq 10 \mu s, D = 0.005$	I_{FM}	1	0.2	A
Sperrspannung ¹⁾ Reverse voltage	V_R	12		V
Leistungsaufnahme Power consumption $T_A \leq 25 \text{ °C}$	P_{tot}	80		mW
Wärmewiderstand ²⁾ Thermal resistance Sperrschicht/Umgebung Junction/ambient Sperrschicht/Lötpad Junction/soldering point Montage auf PC-Board FR 4 (Padgröße $\geq 16 \text{ mm}^2$) mounted on PC board FR 4 (pad size $\geq 16 \text{ mm}^2$) Minimale Beinchenlänge Minimum lead length	$R_{th JA}$ $R_{th JS}$	500 280		K/W K/W

1) für kurzzeitigen Betrieb geeignet / suitable for short term application

2) R_{th} erhöht sich um 13 K/W pro mm Beinchenlänge.
Each additional 1 mm of lead length increases R_{th} by 13 K/W.

Kennwerte ($T_A = 25\text{ °C}$)

Characteristics

Bezeichnung Parameter	Symbol Symbol	Werte Values			Einheit Unit
		LS	LO	LY	
Wellenlänge des emittierten Lichtes (typ.) Wavelength at peak emission $I_F = 20\text{ mA}$	λ_{peak}	645	610	591	nm
Dominantwellenlänge (typ.) Dominant wavelength $I_F = 20\text{ mA}$	λ_{dom}	633	606	587	nm
Spektrale Bandbreite bei 50 % $I_{\text{rel max}}$ (typ.) Spectral bandwidth at 50 % $I_{\text{rel max}}$ $I_F = 20\text{ mA}$	$\Delta\lambda$	16	16	15	nm
Abstrahlwinkel bei 50 % I_V (Vollwinkel) (typ.) Viewing angle at 50 % I_V	2ϕ	40	40	40	Grad deg.
Durchlassspannung ¹⁾ (typ.) Forward voltage ¹⁾ (max.) $I_F = 20\text{ mA}$	V_F ¹⁾ V_F	2.0 2.4	2.0 2.4	2.0 2.4	V V
Sperrstrom (typ.) Reverse current (max.) $V_R = 12\text{ V}$	I_R I_R	0.01 10	0.01 10	0.01 10	μA μA
Temperaturkoeffizient von λ_{peak} (typ.) Temperature coefficient of λ_{peak} $I_F = 20\text{ mA}; -10\text{ °C} \leq T \leq 100\text{ °C}$	$TC_{\lambda_{\text{peak}}}$	0.14	0.13	0.13	nm/K
Temperaturkoeffizient von λ_{dom} (typ.) Temperature coefficient of λ_{dom} $I_F = 20\text{ mA}; -10\text{ °C} \leq T \leq 100\text{ °C}$	$TC_{\lambda_{\text{dom}}}$	0.05	0.07	0.10	nm/K
Temperaturkoeffizient von V_F (typ.) Temperature coefficient of V_F $I_F = 20\text{ mA}; -10\text{ °C} \leq T \leq 100\text{ °C}$	TC_V	- 2.0	- 1.7	- 2.5	mV/K
Optischer Wirkungsgrad (typ.) Optical efficiency $I_F = 20\text{ mA}$	η_{opt}	7	11	11	lm/W

¹⁾ Spannungswerte werden mit einer Stromeinprägedauer von 1 ms und einer Genauigkeit von $\pm 0,1\text{ V}$ ermittelt.
Voltages are tested at a current pulse duration of 1 ms and a tolerance of $\pm 0.1\text{ V}$.

Helligkeits-Gruppierungsschema
Luminous Intensity Groups

Lichtgruppe Luminous Intensity Group	Lichtstärke Luminous Intensity I_v (mcd)
S	180 ... 280
T	280 ... 450
U	450 ... 710
V	710 ... 1120
AW	1120 ... 1800
BW	1800 ... 2800

Helligkeitswerte werden mit einer Stromeinprägedauer von 25 ms und einer Genauigkeit von ±11 % ermittelt.
 Luminous intensity is tested at a current pulse duration of 25 ms and a tolerance of ±11 %.

Relative spektrale Emission $I_{rel} = f(\lambda)$, $T_A = 25\text{ °C}$, $I_F = 20\text{ mA}$

Relative Spectral Emission

$V(\lambda)$ = spektrale Augenempfindlichkeit

Standard eye response curve

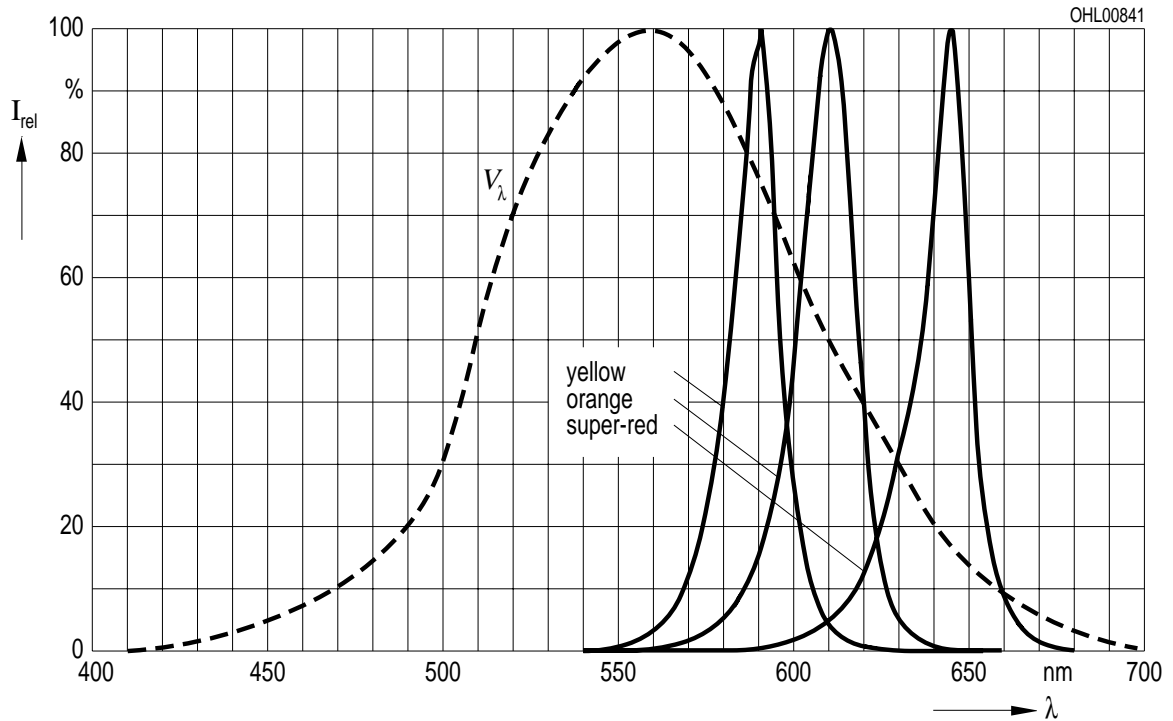

Abstrahlcharakteristik $I_{rel} = f(\varphi)$

Radiation Characteristic

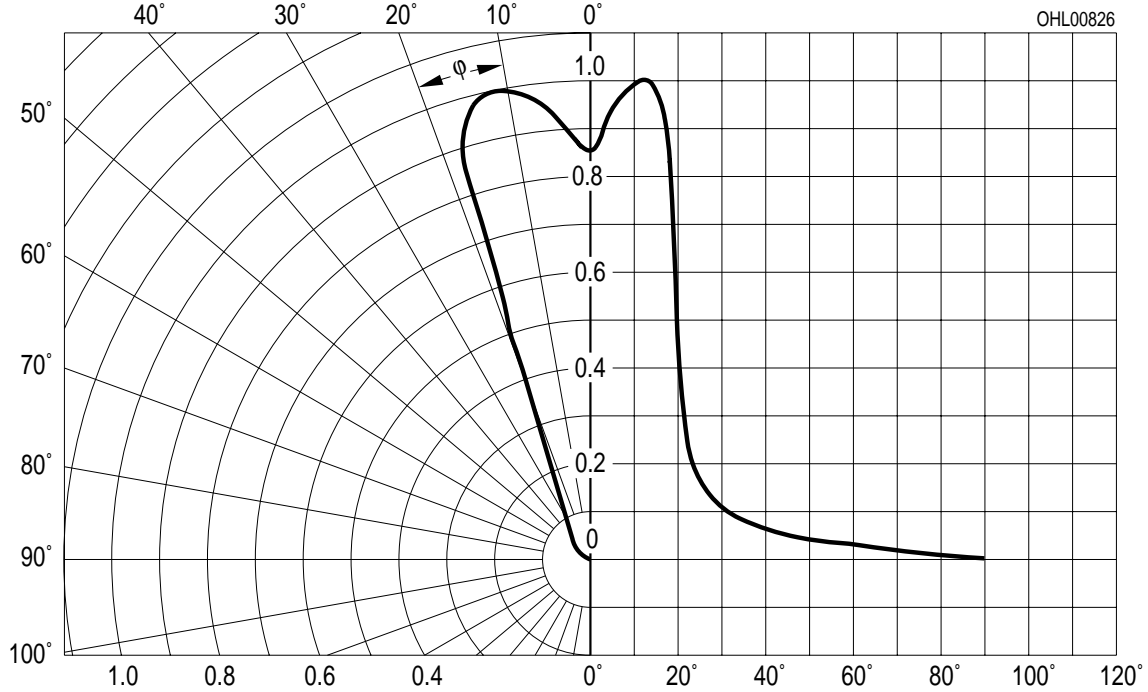

Durchlassstrom $I_F = f(V_F)$
Forward Current

$T_A = 25\text{ °C}$

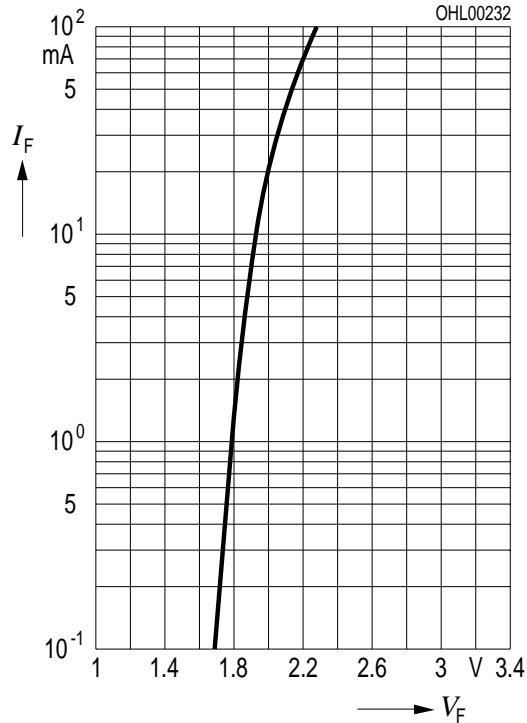

Relative Lichtstärke $I_V/I_{V(20\text{ mA})} = f(I_F)$
Relative Luminous Intensity

$T_A = 25\text{ °C}$

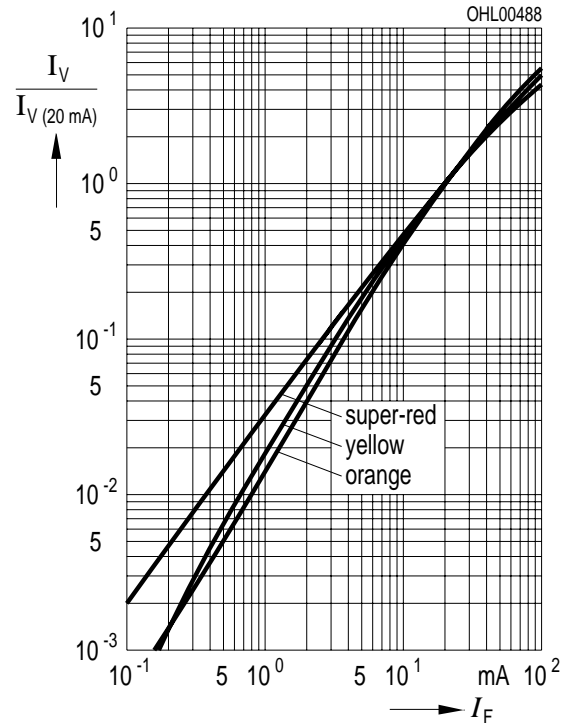

Maximal zulässiger Durchlassstrom $I_F = f(T)$
Max. Permissible Forward Current

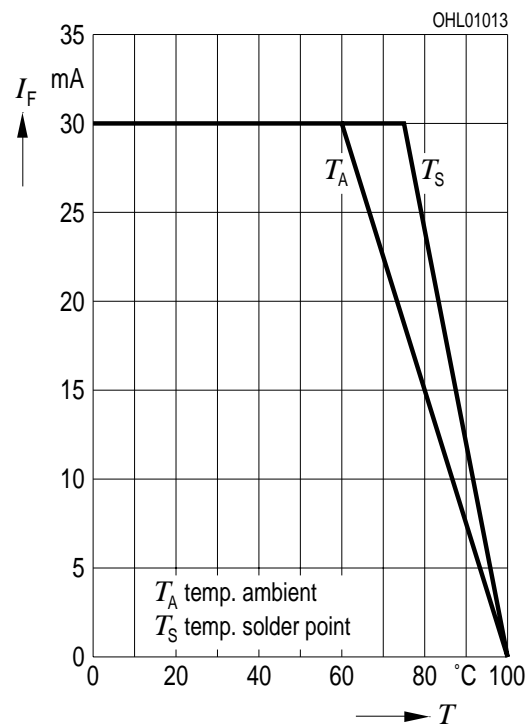

Relative Lichtstärke $I_V/I_{V(25\text{ °C})} = f(T_A)$
Relative Luminous Intensity

$I_F = 20\text{ mA}$

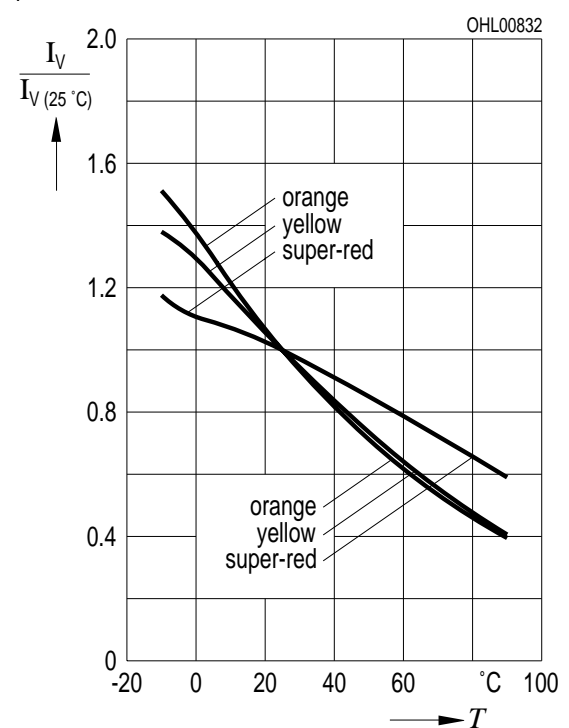

Zulässige Impulsbelastbarkeit $I_F = f(t_p)$
Permissible Pulse Handling Capability

Duty cycle $D =$ parameter, $T_A = 25\text{ °C}$

LS, LO

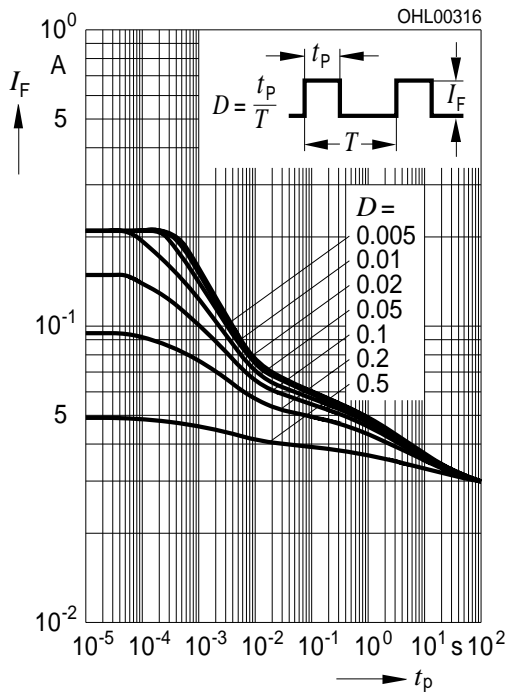

Zulässige Impulsbelastbarkeit $I_F = f(t_p)$
Permissible Pulse Handling Capability

Duty cycle $D =$ parameter, $T_A = 25\text{ °C}$

LY

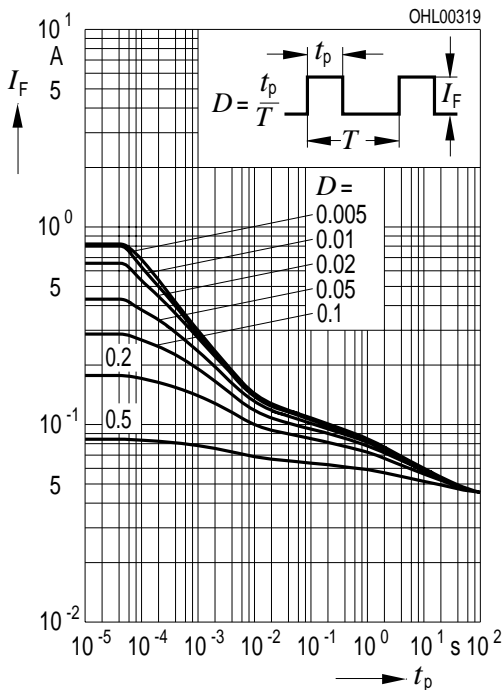

Zulässige Impulsbelastbarkeit $I_F = f(t_p)$
Permissible Pulse Handling Capability

Duty cycle $D =$ parameter, $T_A = 85\text{ °C}$

LS, LO

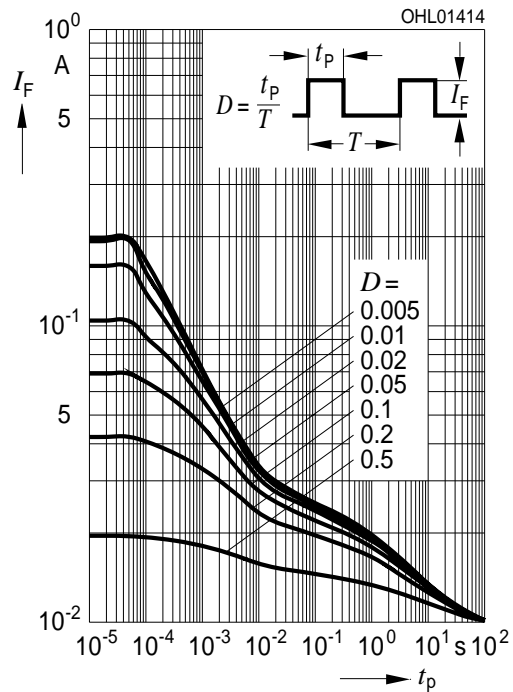

Zulässige Impulsbelastbarkeit $I_F = f(t_p)$
Permissible Pulse Handling Capability

Duty cycle $D =$ parameter, $T_A = 85\text{ °C}$

LY

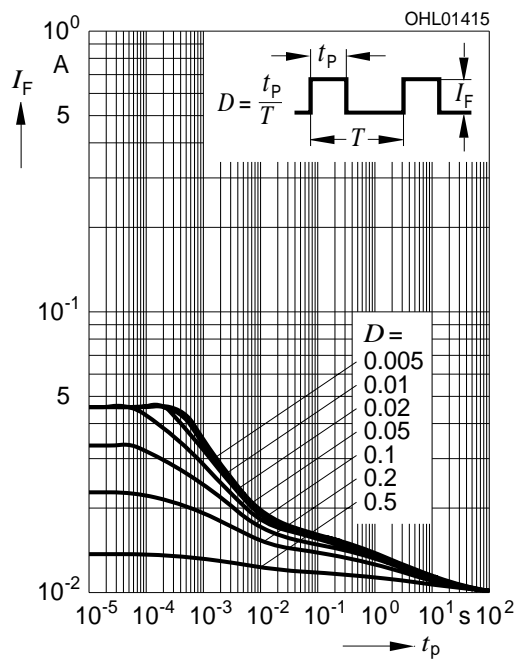

**Maßzeichnung
Package Outlines**

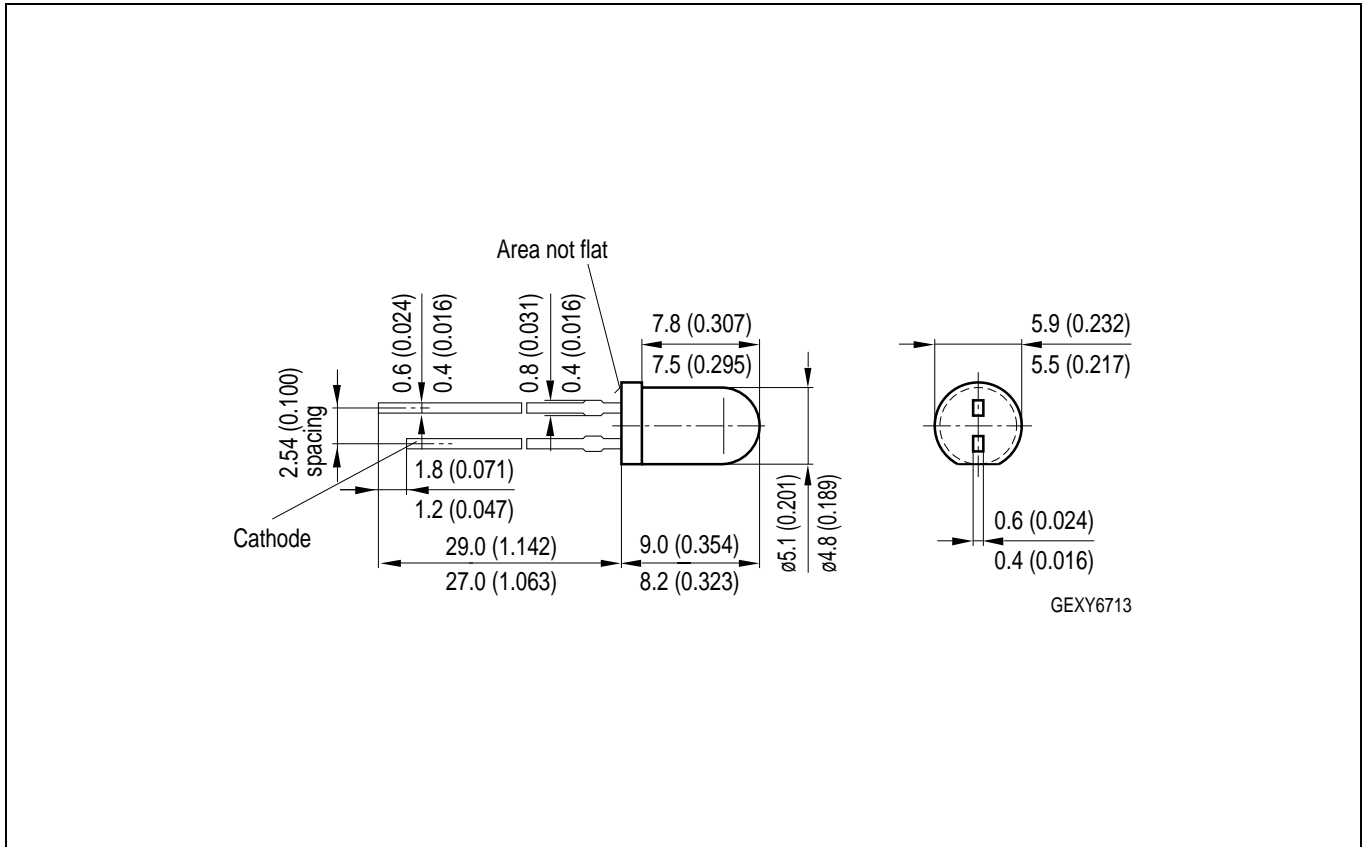

Maße werden wie folgt angegeben: mm (inch) / Dimensions are specified as follows: mm (inch).

Kathodenkennung: kürzerer Lötspieß
Cathode mark: short solder lead
Gewicht / Approx. weight: 0.35 g

Lötbedingungen
Soldering Conditions

Wellenlöten (TTW) (nach CECC 00802)
TTW Soldering (acc. to CECC 00802)

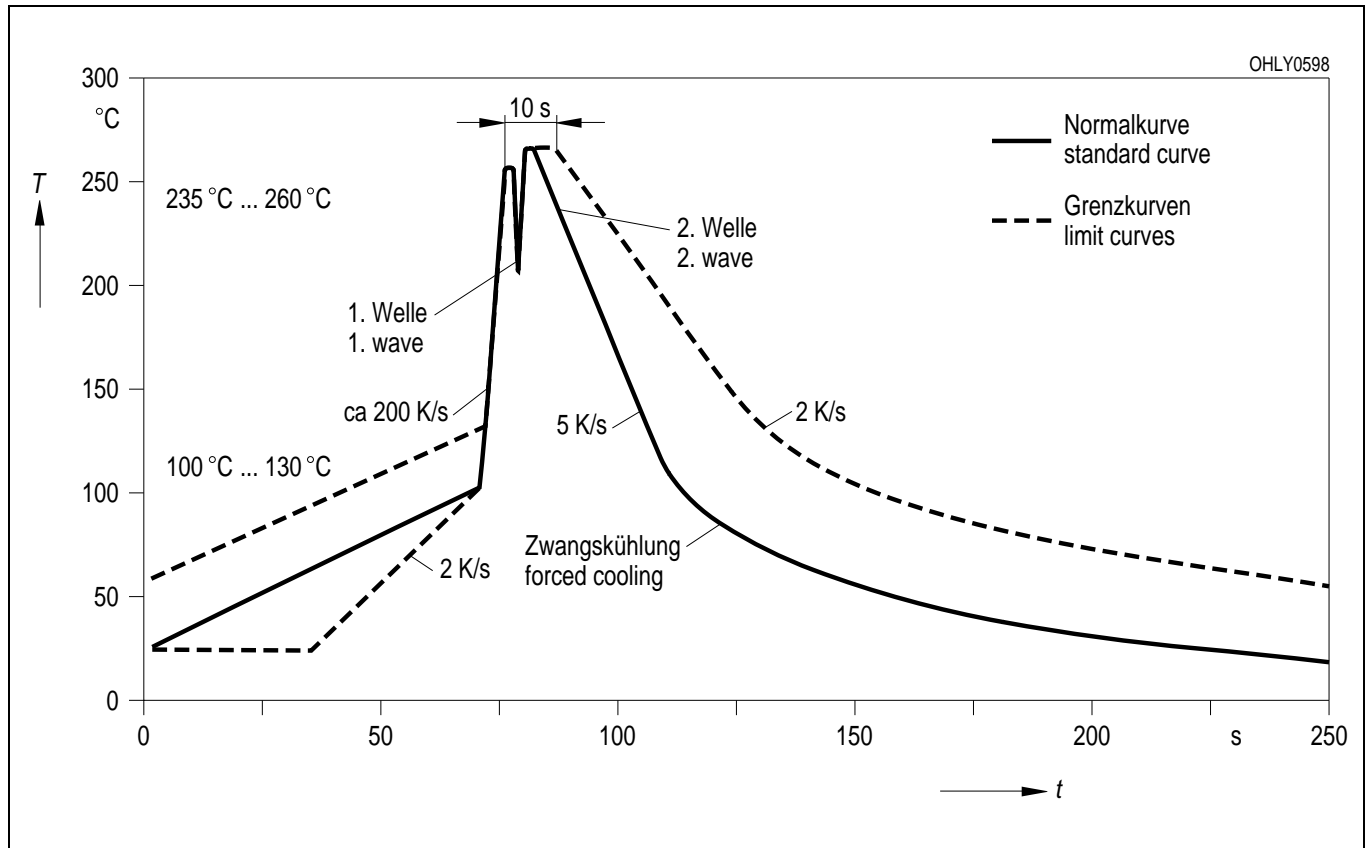

Empfohlenes Lötpaddesign Wellenlöten (TTW)
Recommended Solder Pad TTW Soldering

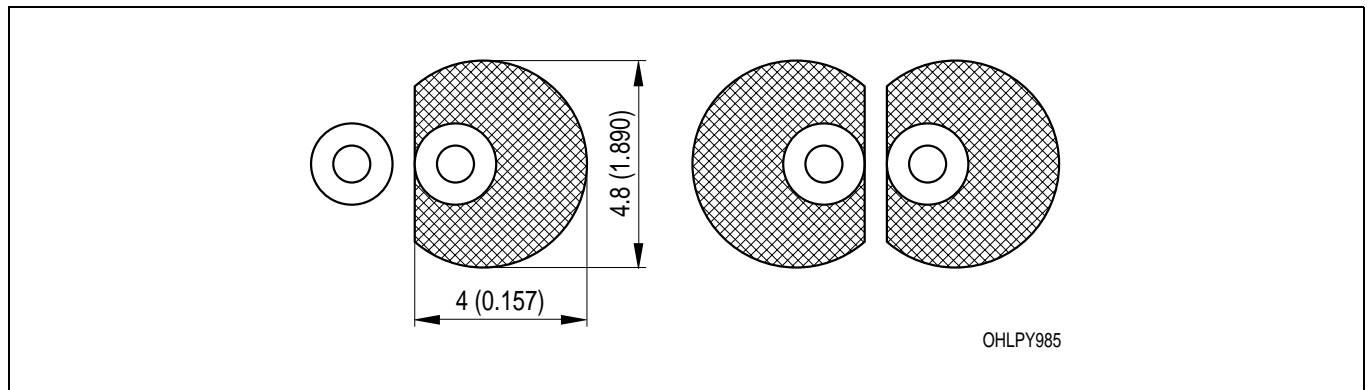

Maße werden wie folgt angegeben: mm (inch) / Dimensions are specified as follows: mm (inch)

Revision History: 2002-12-06		Date of change
Previous Version: 2002-10-07		
Page	Subjects (major changes since last revision)	
3	thermal resistance (footnote)	
4	value (wavelength super-red/amber/yellow)	
11	annotations	2002-07-25
4	value ($TC_{\lambda_{dom}}$ from 0.01 to 0.05 nm/K)	2002-07-25
5	luminous intensity groups	2002-07-30
3, 4	value (reverse voltage from 3 V to 12 V)	2002-09-18
2, 5	new luminous intensity groups (orange)	2002-09-26
all	removal of "amber"	2002-10-01
7	new diagram for rel. lum. intensity (I_F) (OHL00233 to OHL00488)	2002-10-01
7	new diagram for rel. lum. intensity (T_A) (OHL00238 to OHL00832)	2002-10-01
5	new diagram for rel. spec. emission (OHL00235 to OHL00841)	2002-10-07
1	ESD-withstand voltage	2002-12-06

Published by OSRAM Opto Semiconductors GmbH
 Wernerwerkstrasse 2, D-93049 Regensburg

© All Rights Reserved.

Attention please!

The information describes the type of component and shall not be considered as assured characteristics. All typical data and graphs are basing on representative samples, but don't represent the production range. If requested, e.g. because of technical improvements, these typ. data will be changed without any further notice.

Terms of delivery and rights to change design reserved. Due to technical requirements components may contain dangerous substances. For information on the types in question please contact our Sales Organization.

If printed or downloaded, please find the latest version in the Internet.

Packing

Please use the recycling operators known to you. We can also help you – get in touch with your nearest sales office. By agreement we will take packing material back, if it is sorted. You must bear the costs of transport. For packing material that is returned to us unsorted or which we are not obliged to accept, we shall have to invoice you for any costs incurred.

Components used in life-support devices or systems must be expressly authorized for such purpose! Critical components ¹ may only be used in life-support devices or systems ² with the express written approval of OSRAM OS.

¹ A critical component is a component used in a life-support device or system whose failure can reasonably be expected to cause the failure of that life-support device or system, or to affect its safety or the effectiveness of that device or system.

² Life support devices or systems are intended (a) to be implanted in the human body, or (b) to support and/or maintain and sustain human life. If they fail, it is reasonable to assume that the health of the user may be endangered.